

Model FC10 Flow Conditioner Dimensional Drawing

1.5" FC10 Flow Conditioner

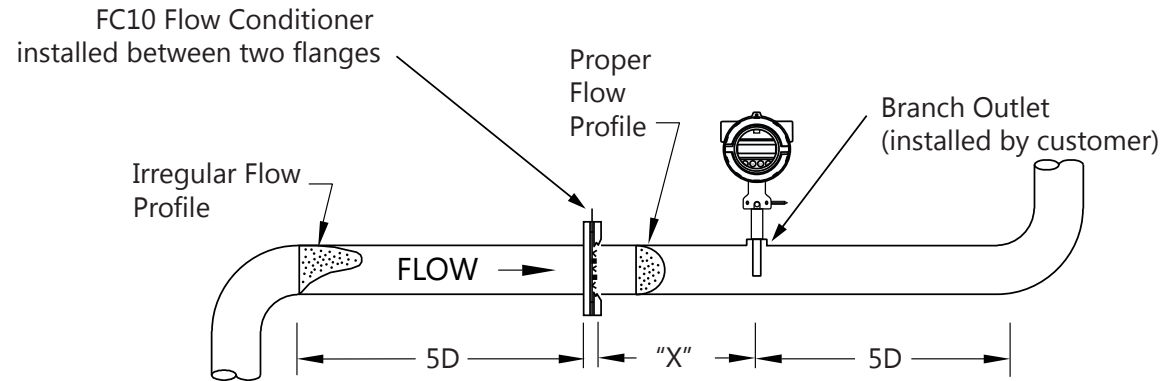
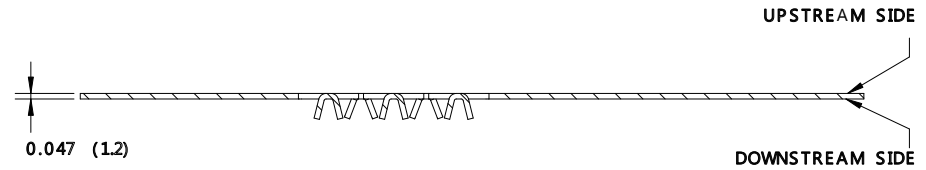
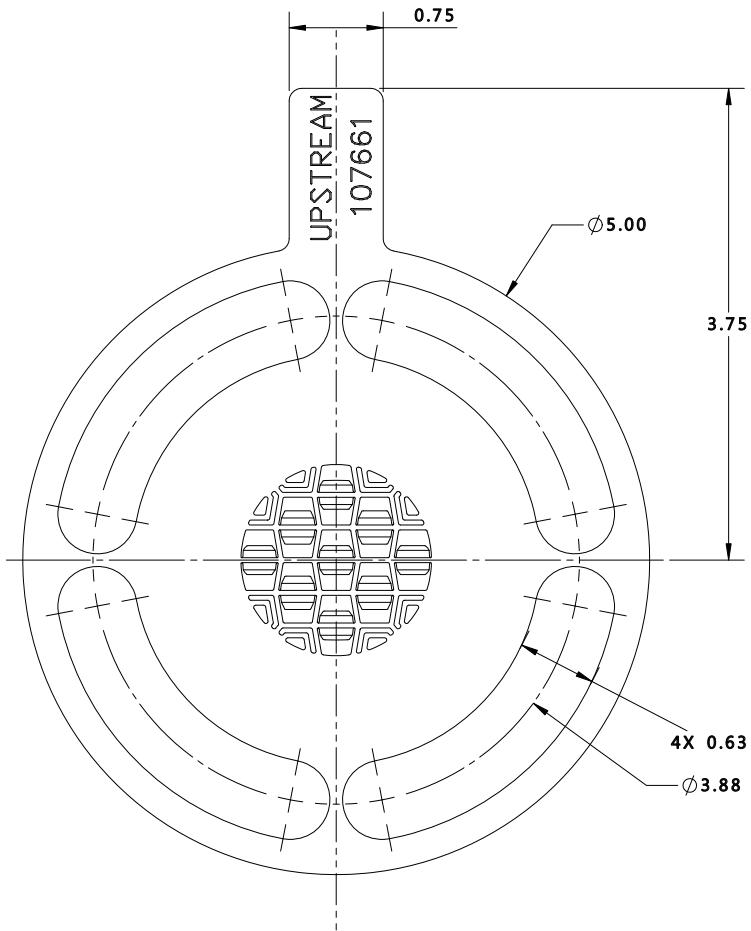

Model FC10 Dimensions

Part Number	Size	"X" Inch (mm)	5D Min. Up/Downstream Inch (mm)
107661	1.50"	6 (152)	8 (203)



399 Reservation Rd
Marina, CA 93933 USA
(831) 384-4300
www.foxthermal.com