

Model FC10 Flow Conditioner Dimensional Drawing

3.0" FC10 Flow Conditioner

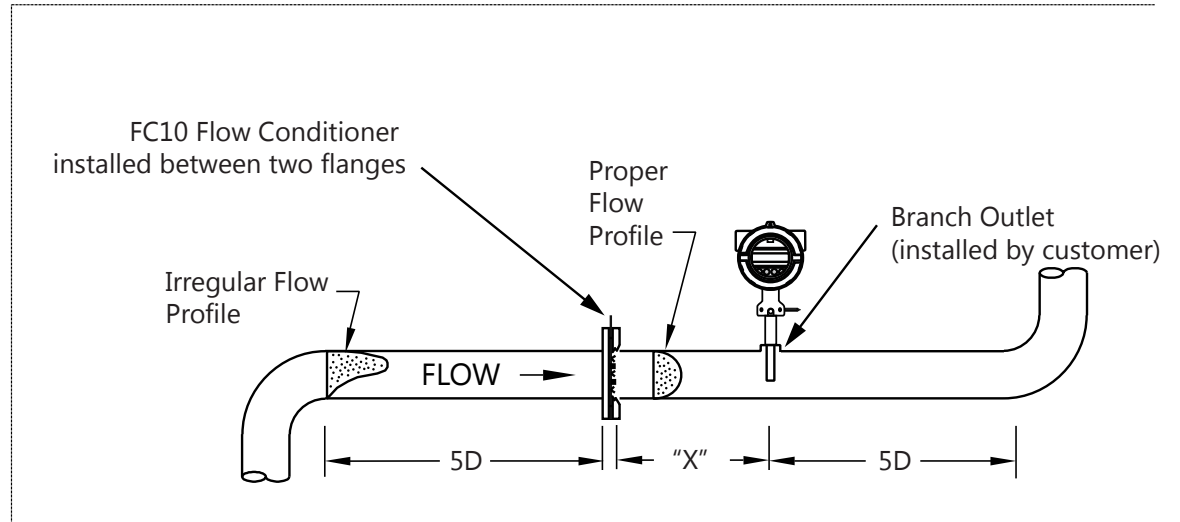
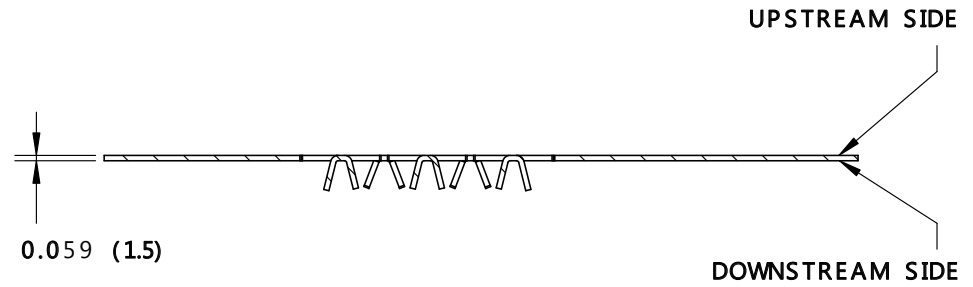
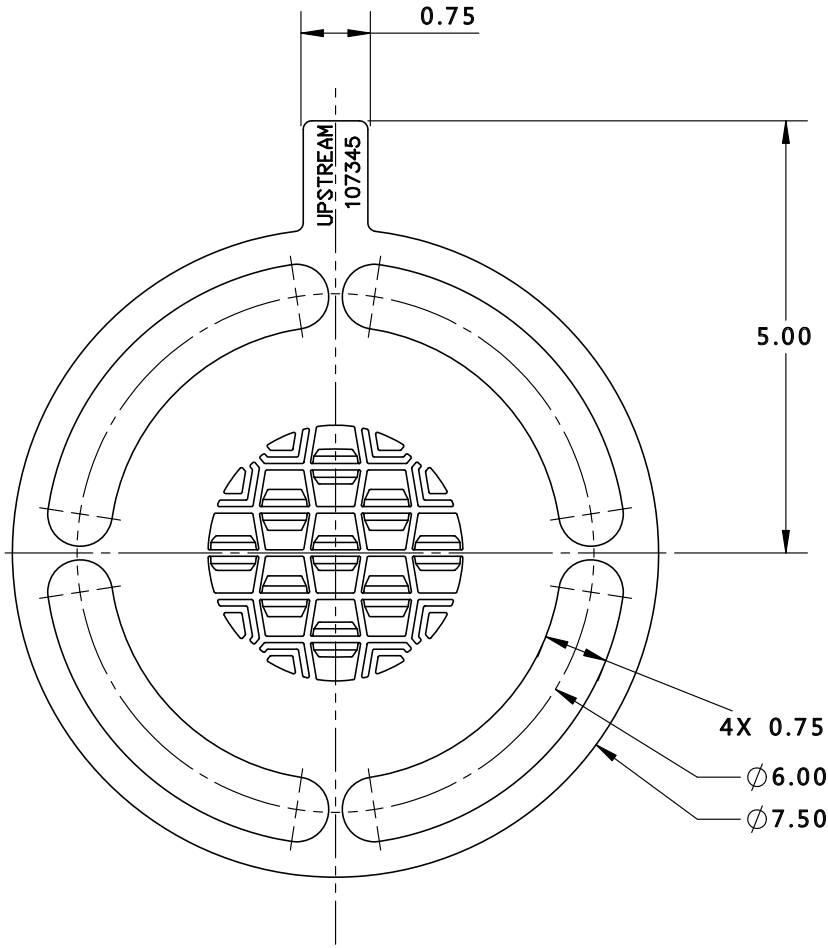

Model FC10 Dimensions

Part Number	Size	"X" Inch (mm)	5D Min. Up/Downstream Inch (mm)
107345	3.00"	9 (229)	18 (457)



399 Reservation Rd
Marina, CA 93933 USA
(831) 384-4300
www.foxthermal.com